

RCCB
 Proudový chránič
 Prúdový chránič
 Wyłącznik różnicowoprądowy
 Intrruptor diferencial
 FI-Schalter
 Interrupteur differential
 УЗО
 ДТЗ
 Diferencijalna zaštitna sklopka

NOARK

Mounting instructions
 Montážní návod
 Montážne inštrukcie
 Instrukcja montazu
 Instrucțiuni de asamblare
 Montageanweisung
 Instructions de montage
 Инструкция по монтажу
 Monteringsanvisning
 Istruzioni di montaggio
 Instrucciones de montaje
 Összeszerelési útmutató

Asennusohjeita
 Montage-instructies
 Instruções de montagem
 Navodila za montažo
 Οδηγίες Εγκατάστασης
 Инструкции за инсталиране
 Monteringsvejledning
 Montažu upute
 Surinkimo instrukcijos
 Instalēšanas instrukcijas
 Скупштина упутство
 Paigaldusjuhendid

Caution: Installation by electricians only
 Varování: Montáž pouze osobou s elektrotech. kvalifikací
 Varovanie: Montáž iba osobou s elektrotech. kvalifikáciou
 Uwaga: Montaż tylko przez uprawnionych instalatorów
 Atenție: Instalare numai de către electricieni
 Vorsicht: Montagenur durch Elektrofachkräfte
 Attention: Montage uniquement par un électricien
 Осторожно: Монтаж только электрика

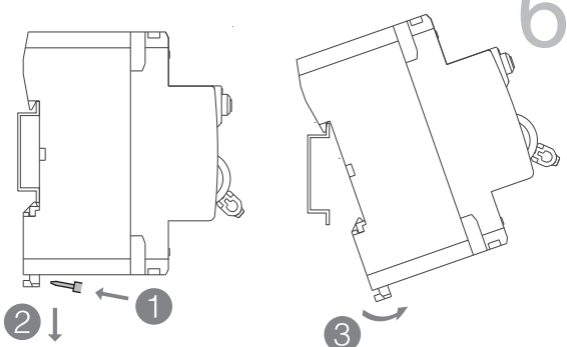
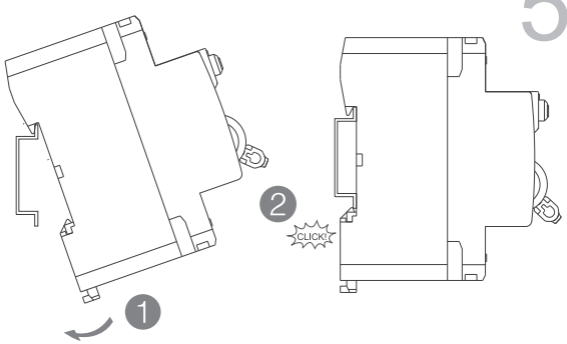
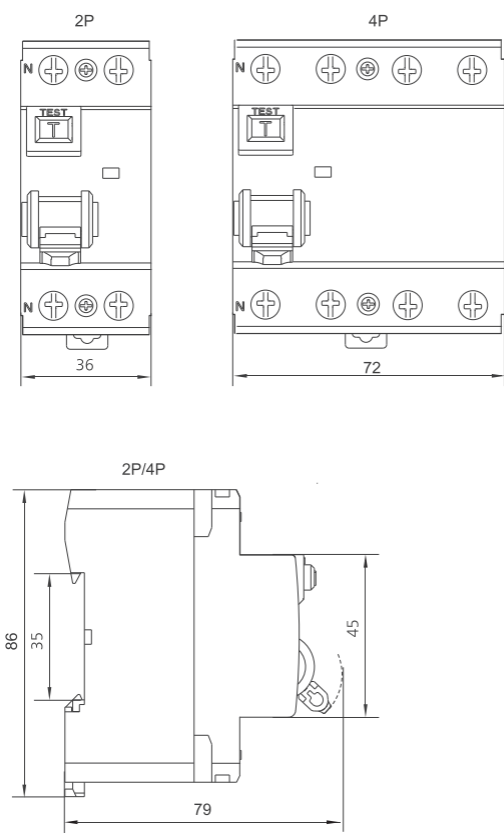

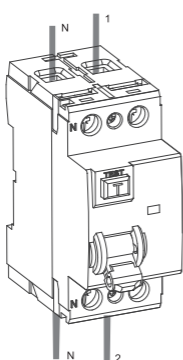

	Z2
(mm ²)	1-35mm ²
(Nm)	2.5Nm

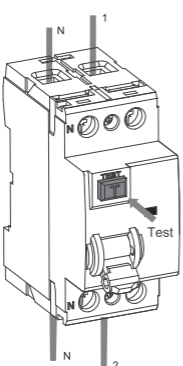
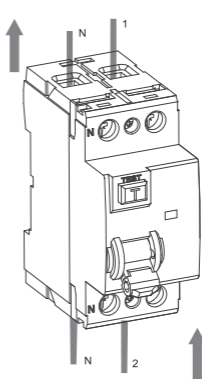
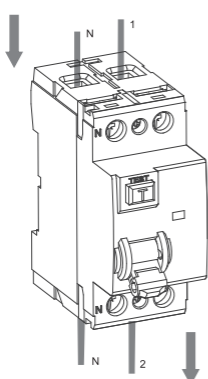
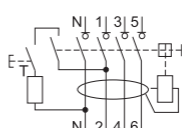
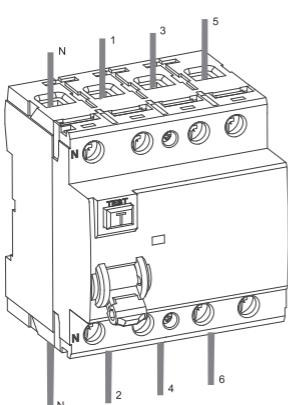
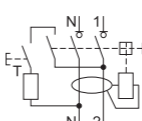

Test monthly
 Testovat měsíčně
 Testovať mesačne
 Test miesięcznie
 Test lunar
 Test månedlige
 Test mensuelle
 Испытание ежемесячно

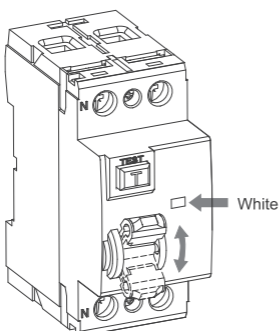

White
 Bílá
 Biela
 Biało
 Albă
 Weiss
 Blanc
 Белая

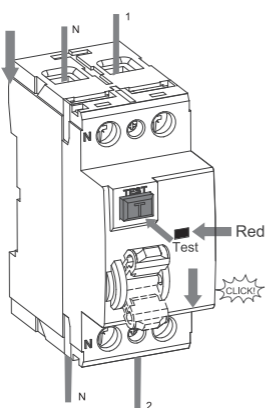
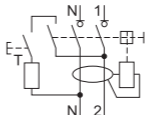

Red
 Červená
 Czerwony
 Roşu
 Rot
 Rouge
 Красный

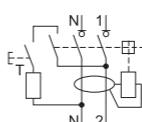

NOARK



Printed with environment-friendly paper

Copyright Noark. All Rights Reserved

www.noark-electric.eu